

DATA SHEET

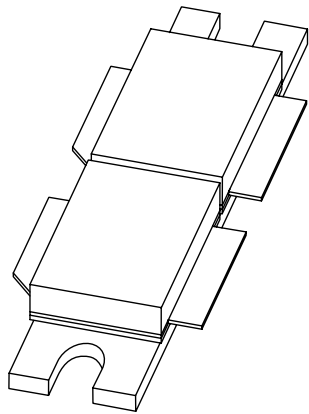

BLV2048

UHF push-pull power transistor

Preliminary specification

1999 Apr 23

UHF push-pull power transistor

BLV2048

FEATURES

- Emitter ballasting resistors for optimum temperature profile
- Gold metallization ensures excellent reliability
- Internal input and output matching for an easy design of wideband circuits.
- AlN substrate package for environmental safety
- Linear amplification with low distortion
- Low spectral regrowth in multichannel power amplifiers according to IS-95.

APPLICATIONS

- Common emitter class-AB operation in base stations for PCN (Personal Communication Network): 1805 - 1880 MHz and PCS (Personal Communication Services): 1910 - 1990 MHz.

DESCRIPTION

NPN silicon planar push-pull power transistor in a 4-lead AlN SOT494A flange package with two ceramic caps. The emitters are connected to the flange.

PINNING - SOT494A

PIN	SYMBOL	DESCRIPTION
1	c	collector 1
2	c	collector 2
3	b	base 1
4	b	base 2
5	e	emitter, connected to flange

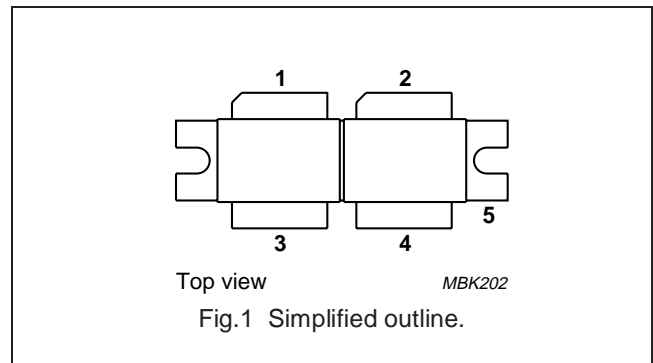

QUICK REFERENCE DATA

RF performance at $T_h = 25\text{ °C}$ in a common emitter test circuit.

MODE OF OPERATION	f (MHz)	V_{CE} (V)	P_L (W)	G_p (dB)	η_c (%)	d_{im} (dBc)
CW, class-AB	2000	26	120	≥ 8	≥ 40	-
2-tone, class-AB	$f_1 = 2000.0; f_2 = 2000.1$	26	120 (PEP)	≥ 8.5	≥ 33	≤ -28

LIMITING VALUES

In accordance with the Absolute Maximum Rating System (IEC 134)

Per section unless otherwise specified.

SYMBOL	PARAMETER	CONDITIONS	MIN.	MAX.	UNIT
V_{CBO}	collector-base voltage	open emitter	-	65	V
V_{CEO}	collector-emitter voltage	open base	-	27	V
V_{EBO}	emitter-base voltage	open collector	-	3	V
I_C	collector current (DC)		-	20	A
$I_{C(AV)}$	average collector current		-	10	A
P_{tot}	total power dissipation	$T_{mb} = 25\text{ °C}$	-	415	W
T_{stg}	storage temperature		-65	+150	°C
T_j	operating junction temperature		-	200	°C

UHF push-pull power transistor

BLV2048

THERMAL CHARACTERISTICS

SYMBOL	PARAMETER	CONDITIONS	VALUE	UNIT
$R_{th\ j-h}$	thermal resistance from junction to heatsink	$P_L = 120\text{ W(PEP)}$; $T_h = 40^\circ\text{C}$; note 1: total device; both sections equally loaded	≤ 0.6	K/W
$R_{th\ mb-h}$	thermal resistance from mounting base to heatsink		0.2	K/W

Note

1. Thermal resistance is determined under nominal 2-tone RF operating conditions.

CHARACTERISTICS

$T_j = 25^\circ\text{C}$; per section; unless otherwise specified.

SYMBOL	PARAMETER	CONDITIONS	MIN.	TYP.	MAX.	UNIT
$V_{(BR)CBO}$	collector-base breakdown voltage	open emitter; $I_C = 40\text{ mA}$	65	–	–	V
$V_{(BR)CEO}$	collector-emitter breakdown voltage	open base; $I_C = 120\text{ mA}$	27	–	–	V
$V_{(BR)EBO}$	emitter-base breakdown voltage	open collector; $I_E = 40\text{ mA}$	3	–	–	V
I_{CES}	collector leakage current	$V_{CE} = 26\text{ V}$; $V_{BE} = 0$	–	–	8	mA
h_{FE}	DC current gain	$V_{CE} = 10\text{ V}$; $I_C = 4\text{ A}$	45	–	100	
C_c	collector capacitance	$V_{CB} = 26\text{ V}$; $I_E = i_e = 0$; $f = 1\text{ MHz}$; note 1	–	72	–	pF
C_{re}	feedback capacitance	$V_{CE} = 26\text{ V}$; $I_C = 0$; $f = 1\text{ MHz}$	–	41	–	pF

Note

1. Capacitance of die only.

UHF push-pull power transistor

BLV2048

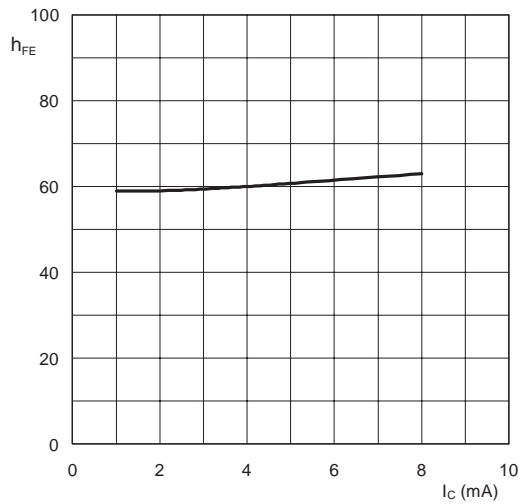

$V_{CE} = 10$ V.

Fig.2 DC current gain as a function of collector current (per section); typical values.

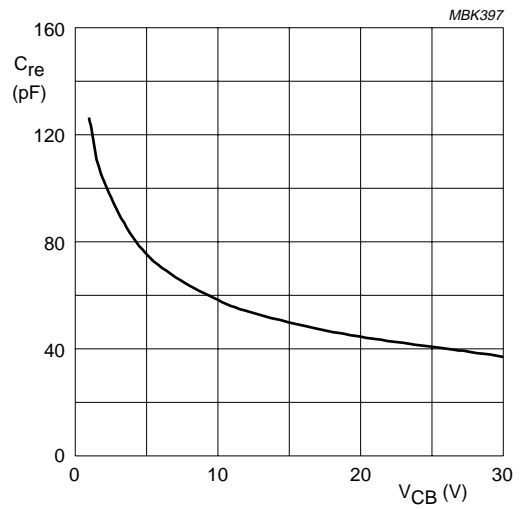

$f = 1$ MHz.

Fig.3 Feedback capacitance as a function of collector-base voltage (per section); typical values.

UHF push-pull power transistor

BLV2048

APPLICATION INFORMATION

RF performance at $T_h = 25\text{ }^\circ\text{C}$ in a common emitter test circuit; bias circuit: $R_i = 0.2\text{ }\Omega$.

MODE OF OPERATION	f (MHz)	V_{CE} (V)	I_{CQ} (mA)	P_L (W)	G_p (dB)	η_c (%)	d_{im} (dBc)	ACP (dBc)
CW, class-AB	2000	26	2x300	120	≥ 8	≥ 40	-	-
2-tone, class-AB	$f_1 = 2000.0; f_2 = 2000.1$	26	2x300	120 (PEP)	≥ 8.5	≥ 33	≤ -28	-
CDMA, class-AB	2000	26	2x500	25	typ. 9	typ. 22	-	≤ -46 (note 1)

Notes

- CDMA testsignal with peak to average ratio of 11.9 dB.
ACP is measured at +/- 885 kHz offset from the centre of the channel (2000 MHz) using a spectrum analyzer with a resolution set to 30 kHz

Ruggedness in class-AB operation

The BLV2048 is capable of withstanding a load mismatch corresponding to $V_{SWR} = 3 : 1$ through all phases under the following conditions: $f_1 = 2000.0\text{ MHz}; f_2 = 2000.1\text{ MHz}; V_{CE} = 26\text{ V}; I_{CQ} = 2 \times 300\text{ mA}; P_L = 120\text{ W (PEP)}; T_{mb} = 25\text{ }^\circ\text{C}$.

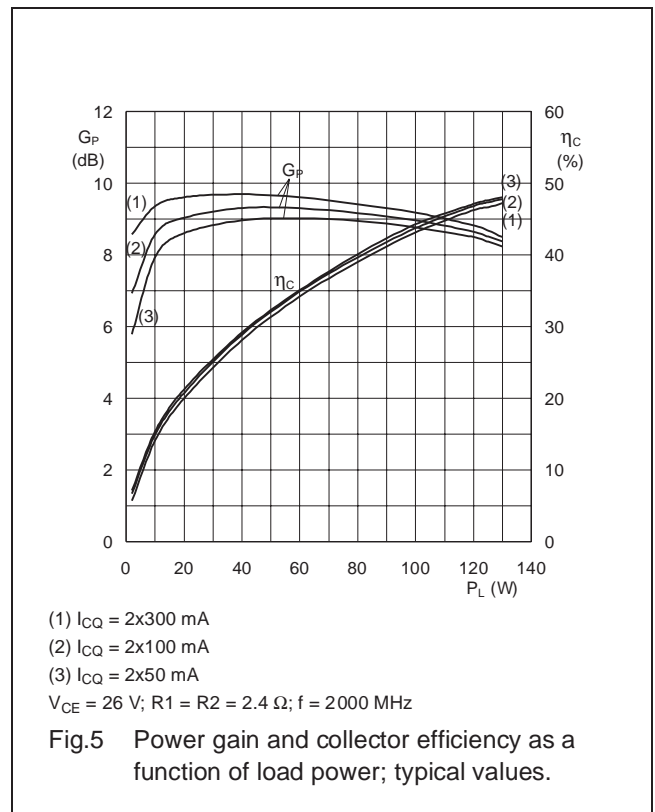
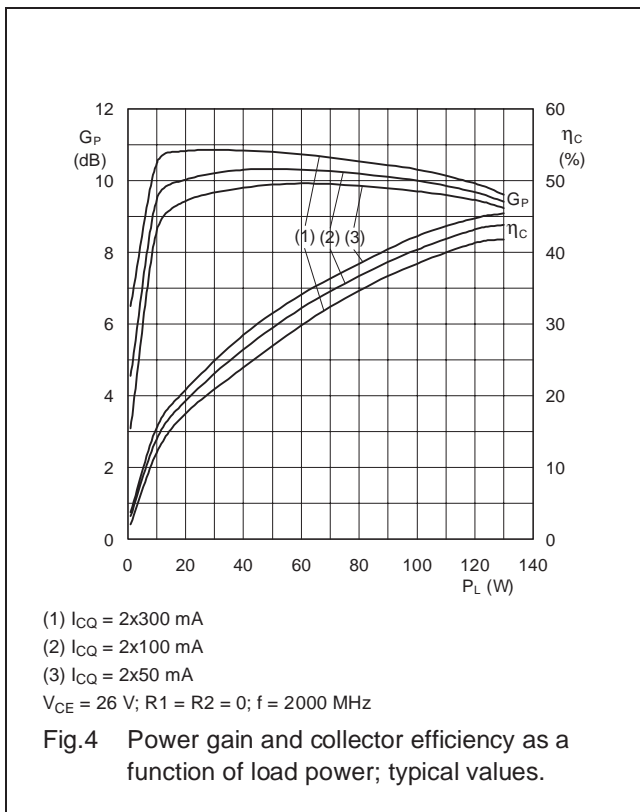

UHF push-pull power transistor

BLV2048

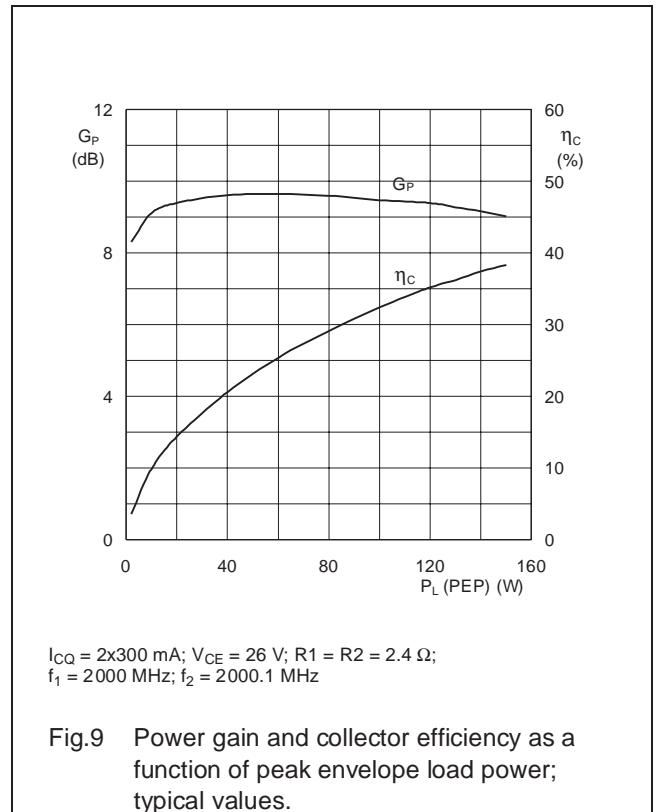
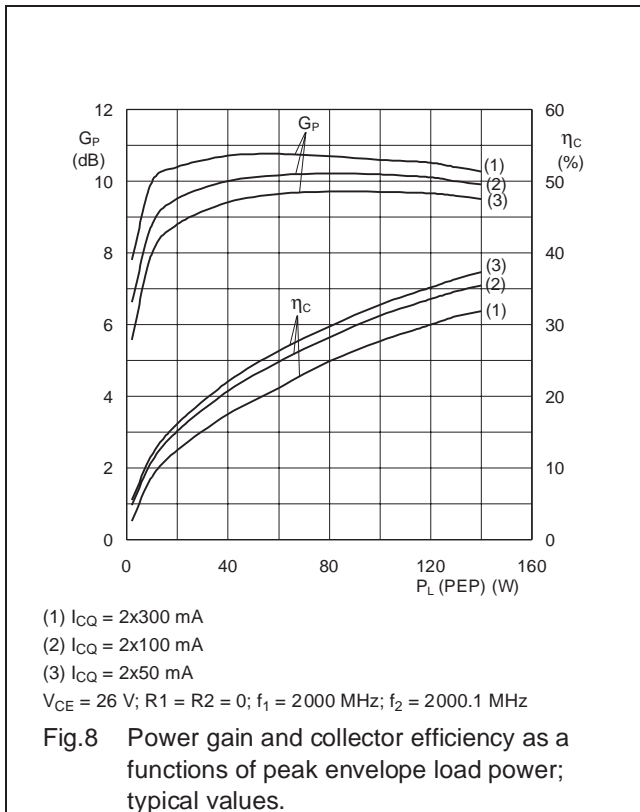
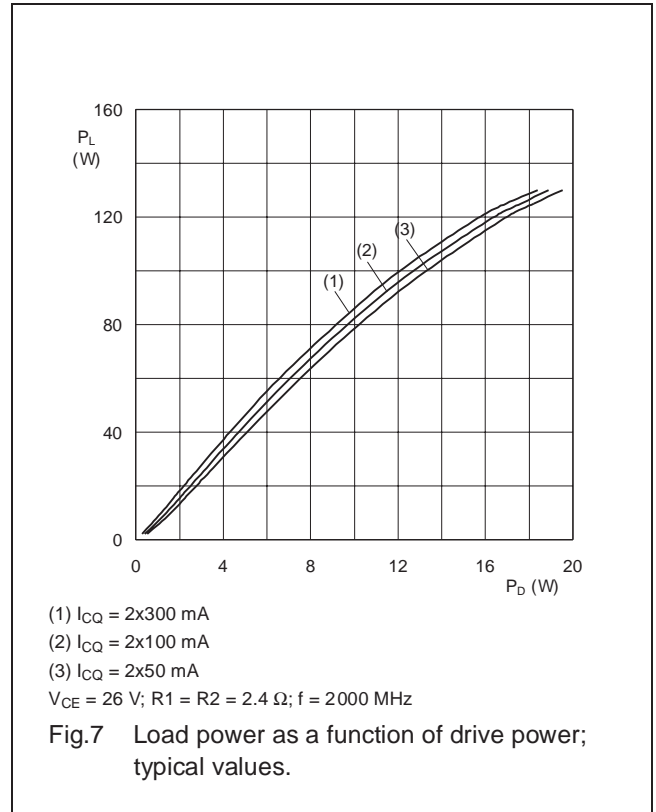
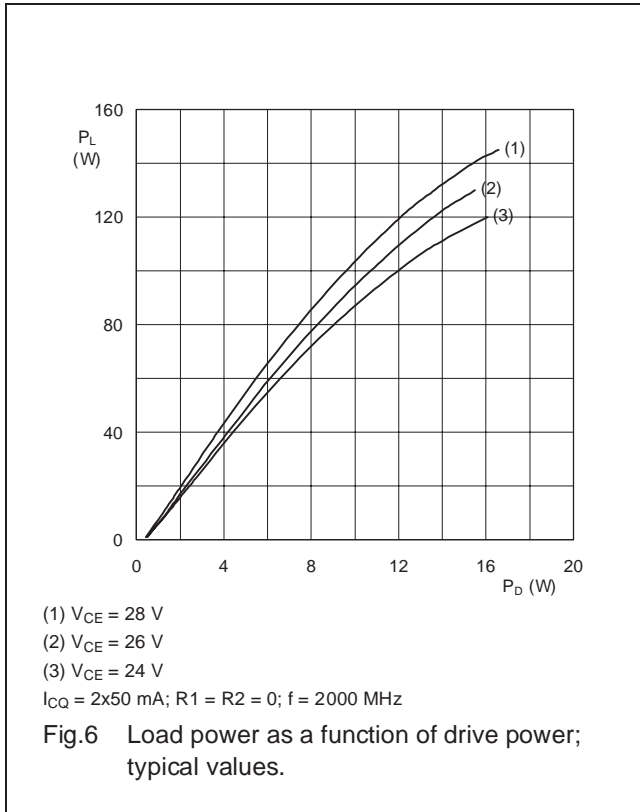

UHF push-pull power transistor

BLV2048

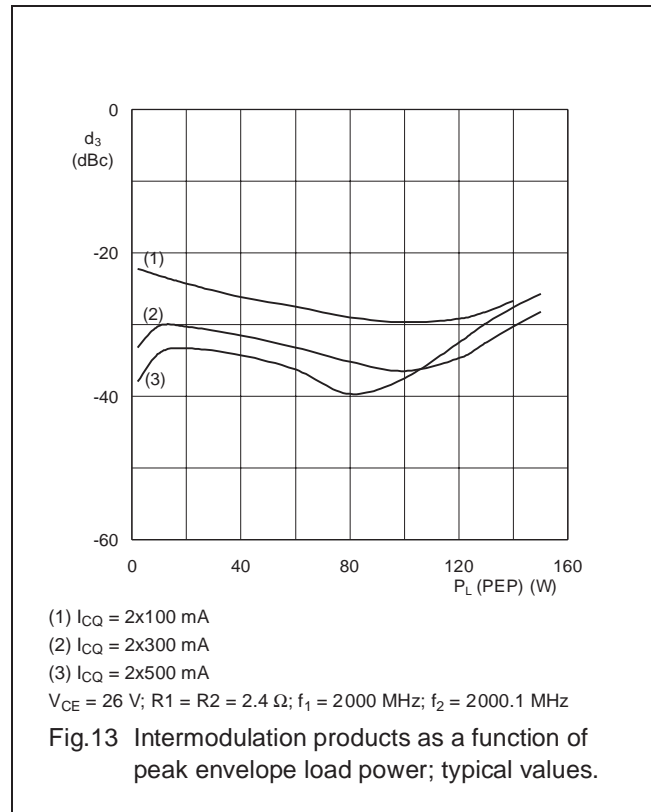
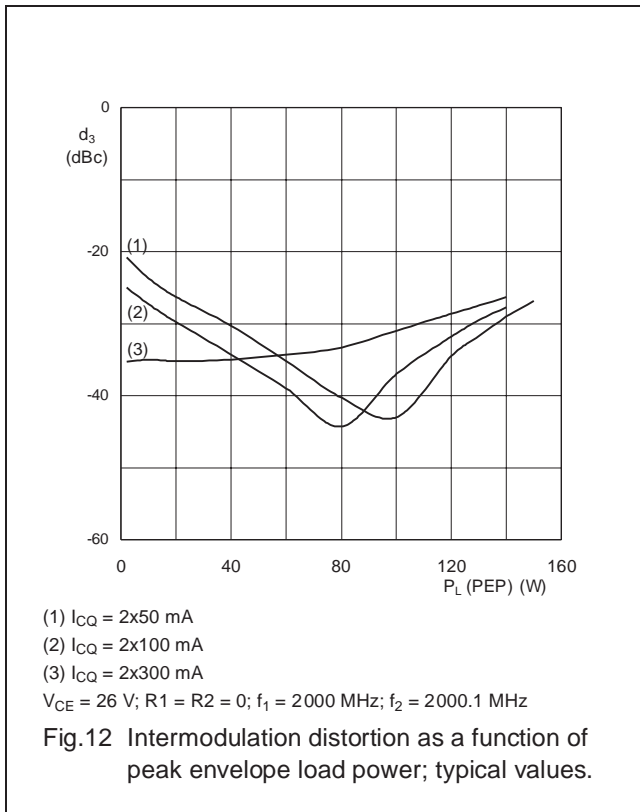
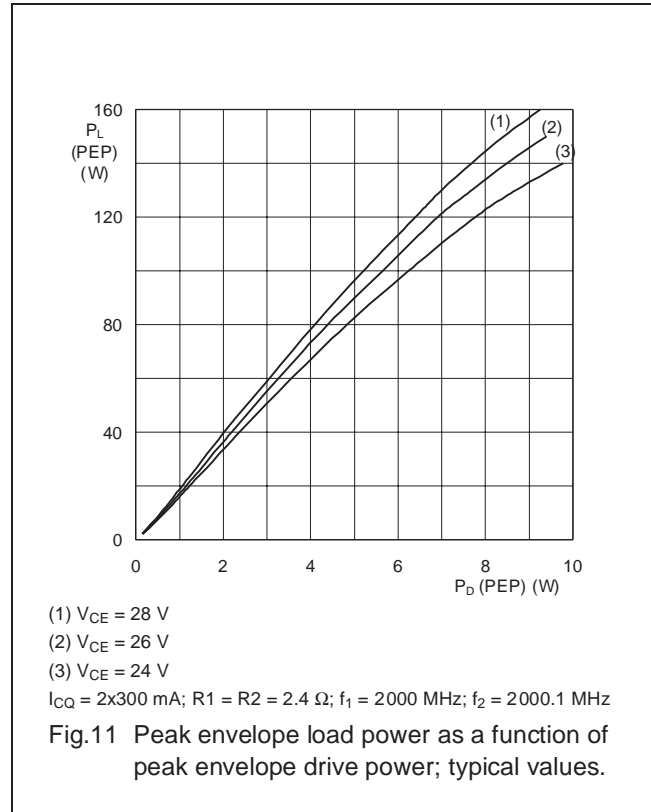
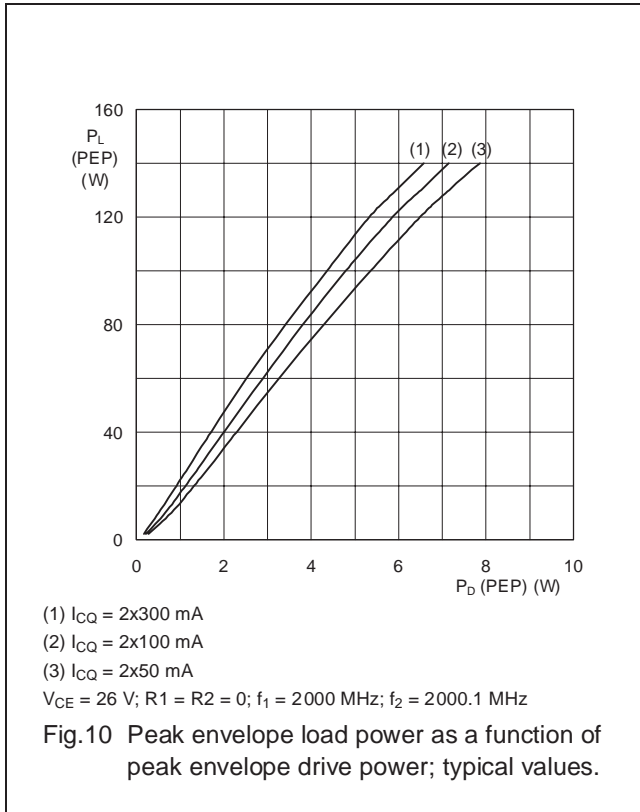

UHF push-pull power transistor

BLV2048

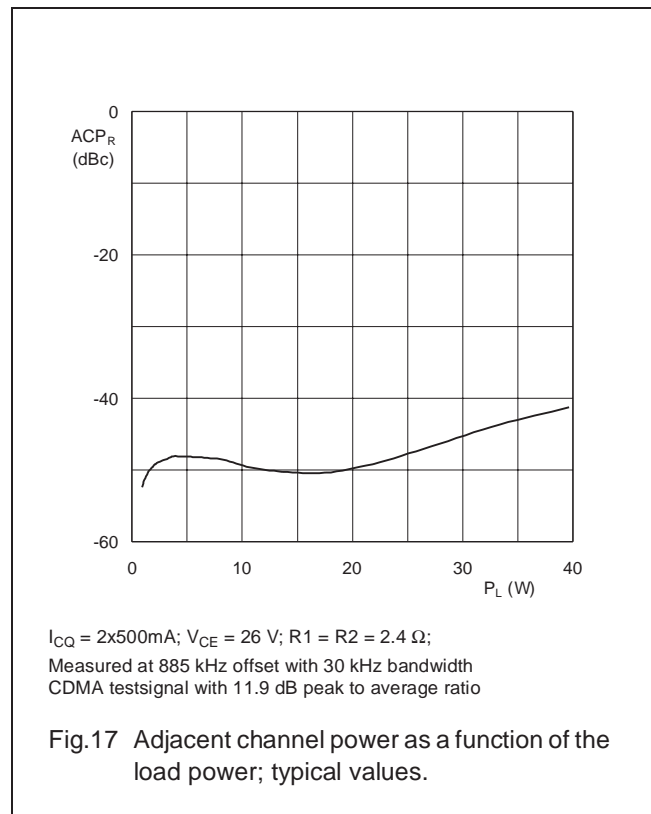
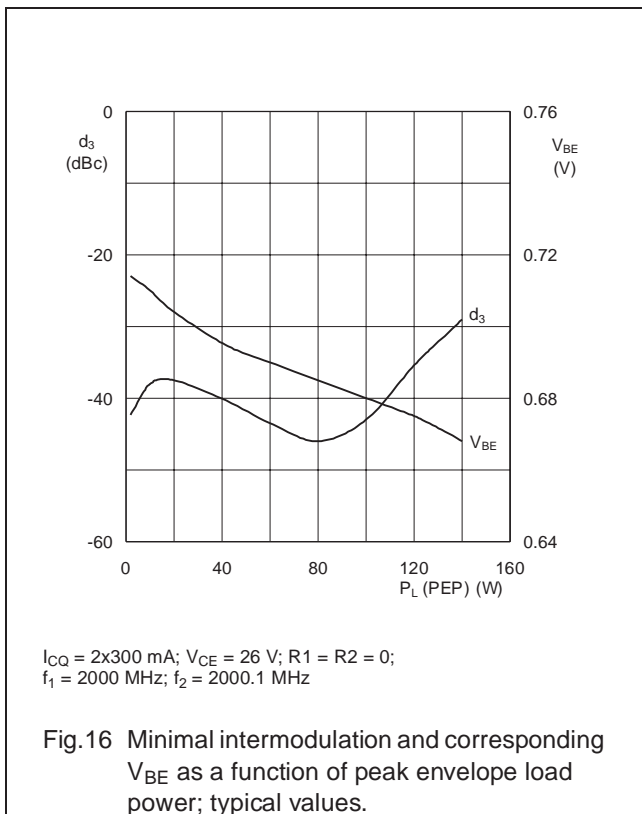
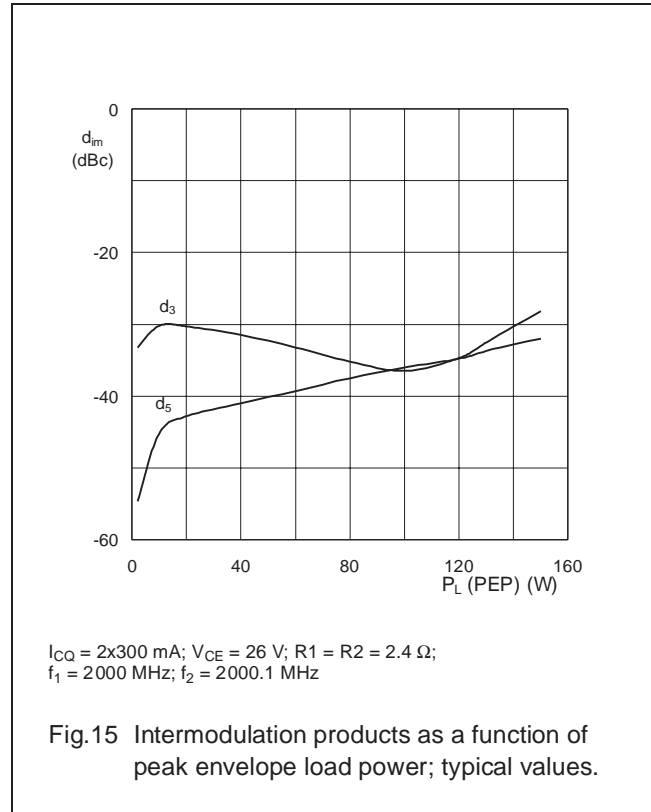
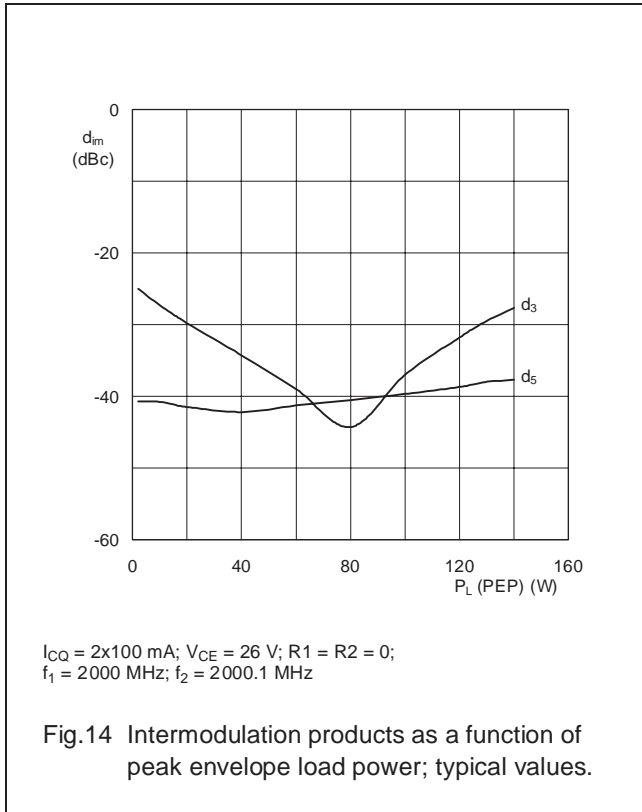

UHF push-pull power transistor

BLV2048

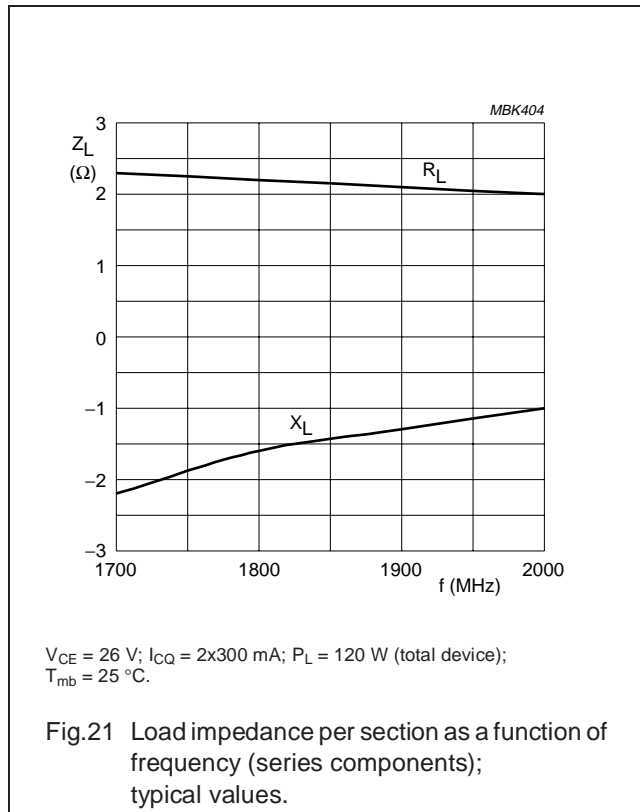
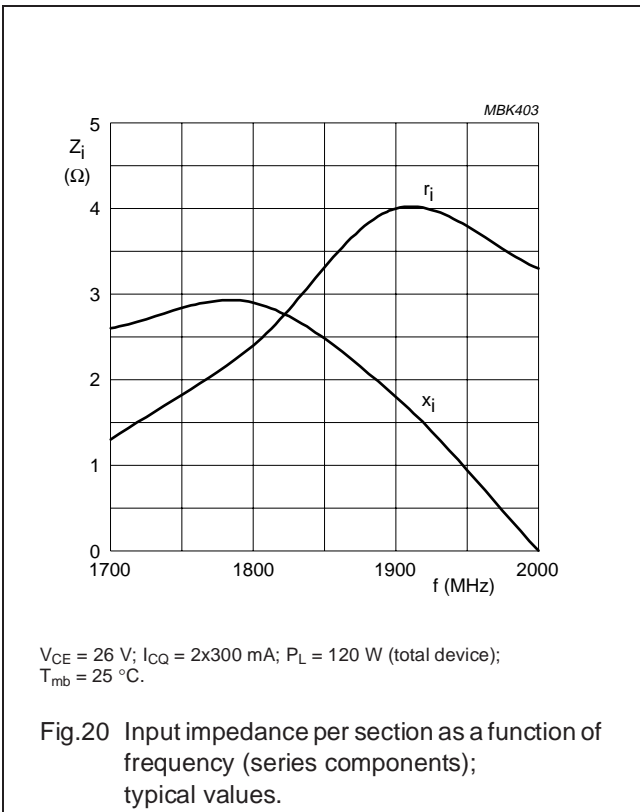
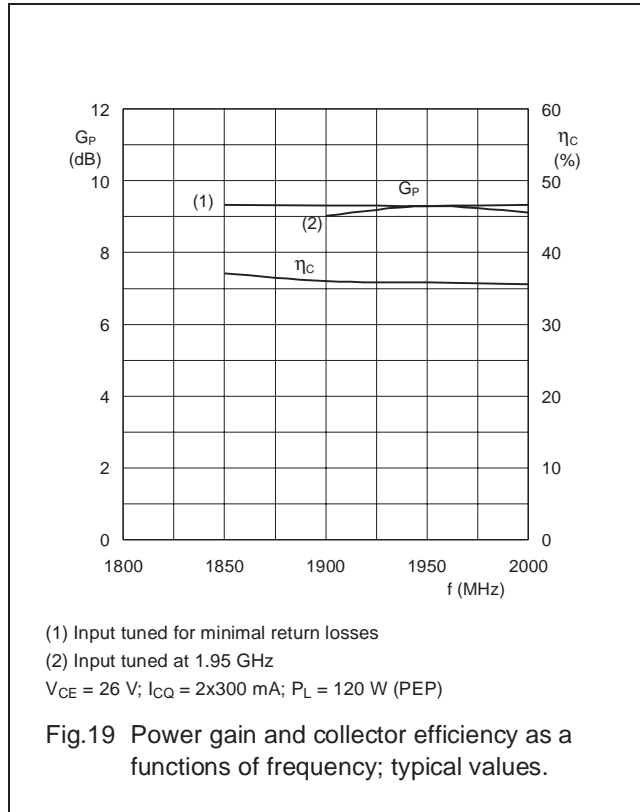
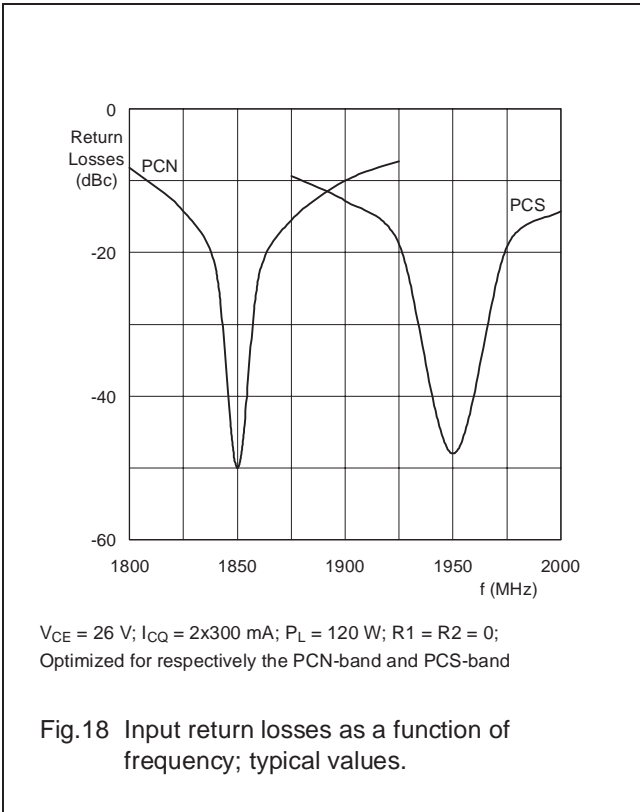

UHF push-pull power transistor

BLV2048

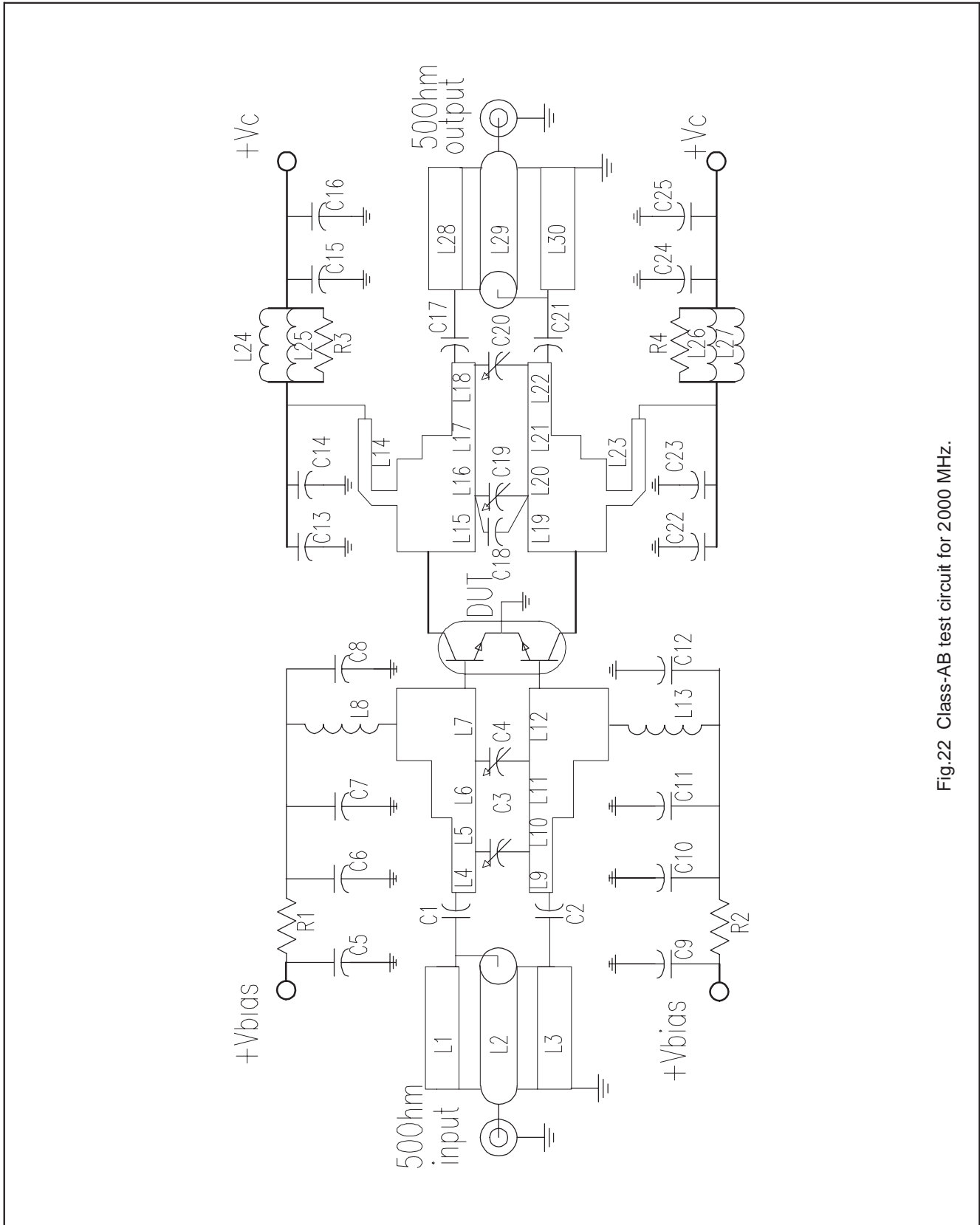

Fig.22 Class-AB test circuit for 2000 MHz.

UHF push-pull power transistor

BLV2048

List of components

COMPONENT	DESCRIPTION	VALUE	DIMENSIONS	CATALOGUE NO.
C1, C2, C13, C17, C21, C22	multilayer ceramic chip capacitor; note 1	10 pF		
C3, C4, C19, C20	Tekelec variable capacitor; type 37271	0.6 to 4.5 pF		
C5, C9, C14, C23	multilayer ceramic chip capacitor; note 1	10 nF		
C6, C10, C16, C25	tantalum SMD capacitor	10 μ F, 35 V		
C7, C11	multilayer ceramic chip capacitor, note 2	100 pF		
C8, C12	multilayer ceramic chip capacitor, note 2	18 pF		
C18	multilayer ceramic chip capacitor; note 1	1.2 pF		
C15, C24	tantalum SMD capacitor	4.7 μ F, 50 V		
L1, L3, L28, L30	stripline; note 3	30 Ω	length 16 mm; width 2 mm	
L2, L29	semi-rigid cable	50 Ω	length 32 mm; width 2.2 mm	
L4 L5, L9, L10	stripline; note 3	25 Ω	length 5 mm; width 2.68 mm	
L6, L11	stripline; note 3	12.5 Ω	length 5.8 mm; width 6.4 mm	
L7, L12	stripline; note 3	7.3 Ω	length 10.6 mm; width 11.7 mm	
L8, L13	2 turns enamelled 1 mm copper wire	12 nH	int.dia. 3 mm; length 4 mm	
L14, L23	stripline; note 3	43.7 Ω	length 12.5 mm; width 1 mm	
L15, L19	stripline; note 3	5.9 Ω	length 6.5 mm; width 15 mm	
L16, L20	stripline; note 3	5.9 Ω	length 5 mm; width 15 mm	
L17, L21	stripline; note 3	9.5 Ω	length 2.5 mm; width 8.8 mm	
L18, L22	stripline; note 3	25 Ω	length 16 mm; width 2.68 mm	
L24, L25, L26, L27	grade 4B1 ferroxcube chip-bead			4322 020 34420
R1, R2	SMD resistor	2.4 Ω	type PRC201	
R3, R4	SMD resistor	10 Ω	type 0603	

Notes

1. American Technical Ceramics type 100B or capacitor of same quality.
2. American Technical Ceramics type 100A or capacitor of same quality.
3. The striplines are on a double copper-clad printed-circuit board with Teflon dielectric ($\epsilon_r = 6.15$); thickness 0.64 mm.

UHF push-pull power transistor

BLV2048

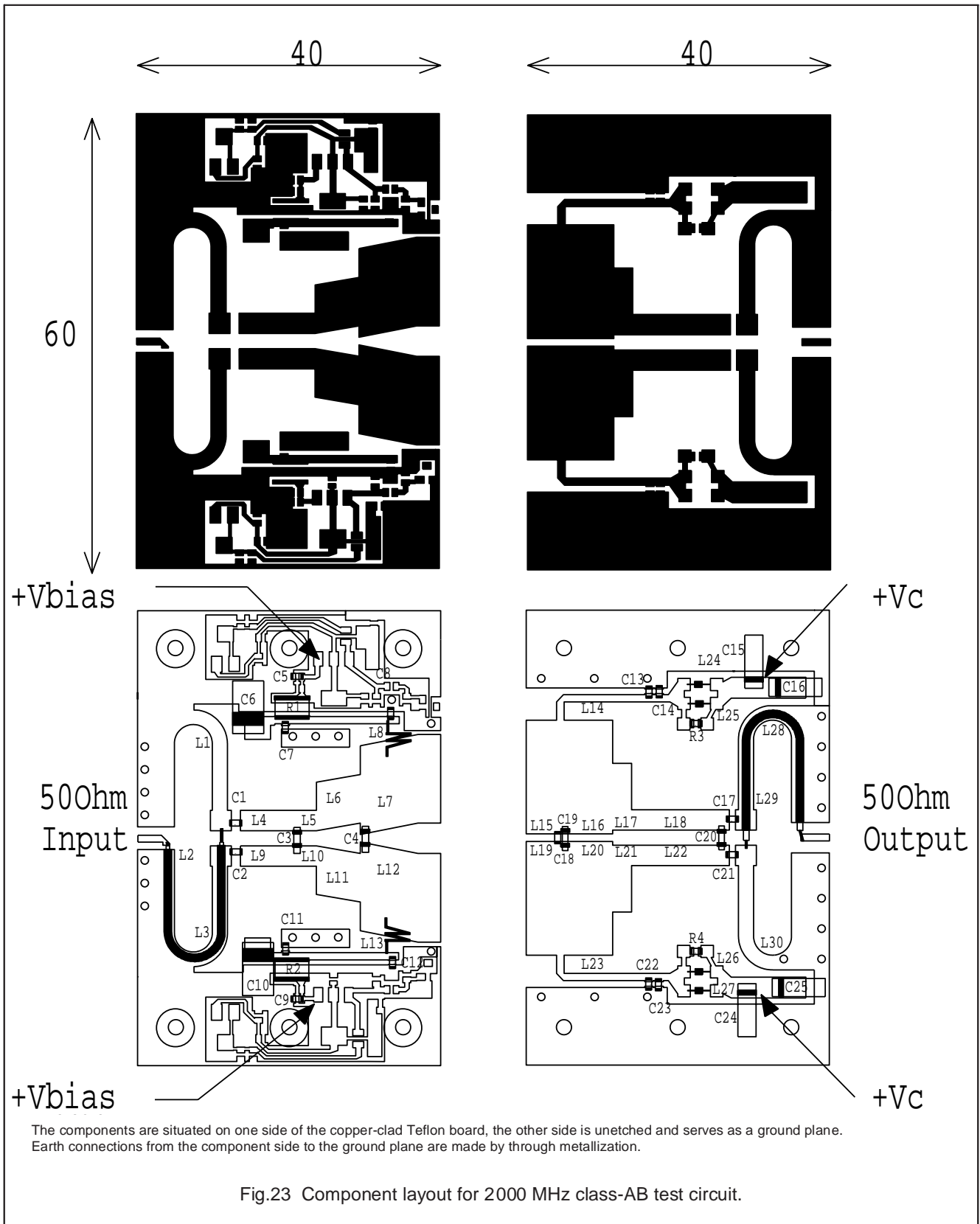

UHF push-pull power transistor

BLV2048

PACKAGE OUTLINE

Flanged double-ended ceramic (AlN) package; 2 mounting holes; 4 leads

SOT494A

Package under development
 Philips Semiconductors reserves the right to make changes without notice.

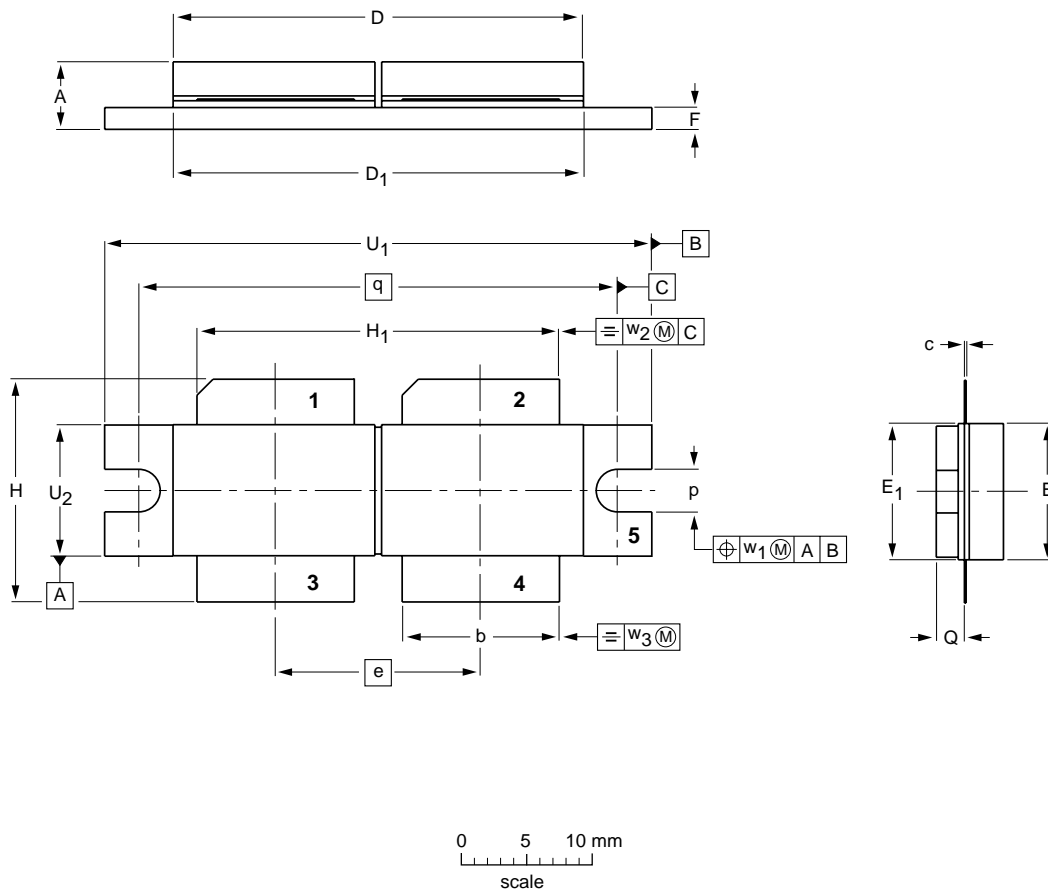

DIMENSIONS (millimetre dimensions are derived from the original inch dimensions)

UNIT	A	b	c	D	D ₁	E	E ₁	e	F	H	H ₁	p	Q	q	U ₁	U ₂	w ₁	w ₂	w ₃
mm	5.26 4.60	11.81 11.56	0.15 0.10	33.96 28.02	31.37 30.61	10.26 10.06	10.29 10.03	15.75	1.66 1.60	16.74 16.48	27.81 27.05	3.30 3.05	2.21 2.06	36.07	41.28 41.02	10.29 10.03	0.25	0.51	0.25
inches	0.207 0.181	0.465 0.455	0.006 0.004	1.337 1.103	1.235 1.205	0.404 0.396	0.405 0.395	0.62	0.065 0.063	0.659 0.649	1.095 1.065	0.130 0.120	0.087 0.081	1.42	1.625 1.615	0.405 0.395	0.01	0.02	0.01

OUTLINE VERSION	REFERENCES				EUROPEAN PROJECTION	ISSUE DATE
	IEC	JEDEC	EIAJ			
SOT494A						99-03-30

UHF push-pull power transistor

BLV2048

DEFINITIONS

Data Sheet Status	
Objective specification	This data sheet contains target or goal specifications for product development.
Preliminary specification	This data sheet contains preliminary data; supplementary data may be published later.
Product specification	This data sheet contains final product specifications.
Limiting values	
Limiting values given are in accordance with the Absolute Maximum Rating System (IEC 134). Stress above one or more of the limiting values may cause permanent damage to the device. These are stress ratings only and operation of the device at these or at any other conditions above those given in the Characteristics sections of the specification is not implied. Exposure to limiting values for extended periods may affect device reliability.	
Application information	
Where application information is given, it is advisory and does not form part of the specification.	

LIFE SUPPORT APPLICATIONS

These products are not designed for use in life support appliances, devices, or systems where malfunction of these products can reasonably be expected to result in personal injury. Philips customers using or selling these products for use in such applications do so at their own risk and agree to fully indemnify Philips for any damages resulting from such improper use or sale.

Philips Semiconductors – a worldwide company

Argentina: see South America

Australia: 34 Waterloo Road, NORTH RYDE, NSW 2113,
Tel. +61 2 9805 4455, Fax. +61 2 9805 4466

Austria: Computerstr. 6, A-1101 WIEN, P.O. Box 213,
Tel. +43 1 60 101 1248, Fax. +43 1 60 101 1210

Belarus: Hotel Minsk Business Center, Bld. 3, r. 1211, Volodarski Str. 6,
220050 MINSK, Tel. +375 172 20 0733, Fax. +375 172 20 0773

Belgium: see The Netherlands

Brazil: see South America

Bulgaria: Philips Bulgaria Ltd., Energoproject, 15th floor,
51 James Bourchier Blvd., 1407 SOFIA,
Tel. +359 2 68 9211, Fax. +359 2 68 9102

Canada: PHILIPS SEMICONDUCTORS/COMPONENTS,
Tel. +1 800 234 7381, Fax. +1 800 943 0087

China/Hong Kong: 501 Hong Kong Industrial Technology Centre,
72 Tat Chee Avenue, Kowloon Tong, HONG KONG,
Tel. +852 2319 7888, Fax. +852 2319 7700

Colombia: see South America

Czech Republic: see Austria

Denmark: Sydhavnsgade 23, 1780 COPENHAGEN V,
Tel. +45 33 29 3333, Fax. +45 33 29 3905

Finland: Sinikalliontie 3, FIN-02630 ESPOO,
Tel. +358 9 615 800, Fax. +358 9 6158 0920

France: 51 Rue Carnot, BP317, 92156 SURESNES Cedex,
Tel. +33 1 4099 6161, Fax. +33 1 4099 6427

Germany: Hammerbrookstraße 69, D-20097 HAMBURG,
Tel. +49 40 2353 60, Fax. +49 40 2353 6300

Hungary: see Austria

India: Philips INDIA Ltd, Band Box Building, 2nd floor,
254-D, Dr. Annie Besant Road, Worli, MUMBAI 400 025,
Tel. +91 22 493 8541, Fax. +91 22 493 0966

Indonesia: PT Philips Development Corporation, Semiconductors Division,
Gedung Philips, Jl. Buncit Raya Kav.99-100, JAKARTA 12510,
Tel. +62 21 794 0040 ext. 2501, Fax. +62 21 794 0080

Ireland: Newstead, Clonskeagh, DUBLIN 14,
Tel. +353 1 7640 000, Fax. +353 1 7640 200

Israel: RAPAC Electronics, 7 Kehilat Saloniki St, PO Box 18053,
TEL AVIV 61180, Tel. +972 3 645 0444, Fax. +972 3 649 1007

Italy: PHILIPS SEMICONDUCTORS, Piazza IV Novembre 3,
20124 MILANO, Tel. +39 2 6752 2531, Fax. +39 2 6752 2557

Japan: Philips Bldg 13-37, Kohnan 2-chome, Minato-ku,
TOKYO 108-8507, Tel. +81 3 3740 5130, Fax. +81 3 3740 5077

Korea: Philips House, 260-199 Itaewon-dong, Yongsan-ku, SEOUL,
Tel. +82 2 709 1412, Fax. +82 2 709 1415

Malaysia: No. 76 Jalan Universiti, 46200 PETALING JAYA, SELANGOR,
Tel. +60 3 750 5214, Fax. +60 3 757 4880

Mexico: 5900 Gateway East, Suite 200, EL PASO, TEXAS 79905,
Tel. +9-5 800 234 7381, Fax +9-5 800 943 0087

Middle East: see Italy

Netherlands: Postbus 90050, 5600 PB EINDHOVEN, Bldg. VB,
Tel. +31 40 27 82785, Fax. +31 40 27 88399

New Zealand: 2 Wagener Place, C.P.O. Box 1041, AUCKLAND,
Tel. +64 9 849 4160, Fax. +64 9 849 7811

Norway: Box 1, Manglerud 0612, OSLO,
Tel. +47 22 74 8000, Fax. +47 22 74 8341

Pakistan: see Singapore

Philippines: Philips Semiconductors Philippines Inc.,
106 Valero St. Salcedo Village, P.O. Box 2108 MCC, MAKATI,
Metro MANILA, Tel. +63 2 816 6380, Fax. +63 2 817 3474

Poland: Ul. Lukiska 10, PL 04-123 WARSZAWA,
Tel. +48 22 612 2831, Fax. +48 22 612 2327

Portugal: see Spain

Romania: see Italy

Russia: Philips Russia, Ul. Usatcheva 35A, 119048 MOSCOW,
Tel. +7 095 755 6918, Fax. +7 095 755 6919

Singapore: Lorong 1, Toa Payoh, SINGAPORE 319762,
Tel. +65 350 2538, Fax. +65 251 6500

Slovakia: see Austria

Slovenia: see Italy

South Africa: S.A. PHILIPS Pty Ltd., 195-215 Main Road Martindale,
2092 JOHANNESBURG, P.O. Box 7430 Johannesburg 2000,
Tel. +27 11 470 5911, Fax. +27 11 470 5494

South America: Al. Vicente Pinzon, 173, 6th floor,
04547-130 SÃO PAULO, SP, Brazil,
Tel. +55 11 821 2333, Fax. +55 11 821 2382

Spain: Balmes 22, 08007 BARCELONA,
Tel. +34 93 301 6312, Fax. +34 93 301 4107

Sweden: Kottbygatan 7, Akalla, S-16485 STOCKHOLM,
Tel. +46 8 5985 2000, Fax. +46 8 5985 2745

Switzerland: Allmendstrasse 140, CH-8027 ZÜRICH,
Tel. +41 1 488 2741 Fax. +41 1 488 3263

Taiwan: Philips Semiconductors, 6F, No. 96, Chien Kuo N. Rd., Sec. 1,
TAIPEI, Taiwan Tel. +886 2 2134 2886, Fax. +886 2 2134 2874

Thailand: PHILIPS ELECTRONICS (THAILAND) Ltd.,
209/2 Sanpavuth-Bangna Road Prakanong, BANGKOK 10260,
Tel. +66 2 745 4090, Fax. +66 2 398 0793

Turkey: Talatpasa Cad. No. 5, 80640 GÜLTEPE/ISTANBUL,
Tel. +90 212 279 2770, Fax. +90 212 282 6707

Ukraine: PHILIPS UKRAINE, 4 Patrice Lumumba str., Building B, Floor 7,
252042 KIEV, Tel. +380 44 264 2776, Fax. +380 44 268 0461

United Kingdom: Philips Semiconductors Ltd., 276 Bath Road, Hayes,
MIDDLESEX UB3 5BX, Tel. +44 181 730 5000, Fax. +44 181 754 8421

United States: 811 East Arques Avenue, SUNNYVALE, CA 94088-3409,
Tel. +1 800 234 7381, Fax. +1 800 943 0087

Uruguay: see South America

Vietnam: see Singapore

Yugoslavia: PHILIPS, Trg N. Pasica 5/v, 11000 BEOGRAD,
Tel. +381 11 62 5344, Fax. +381 11 63 5777

For all other countries apply to: Philips Semiconductors,
International Marketing & Sales Communications, Building BE-p, P.O. Box 218,
5600 MD EINDHOVEN, The Netherlands, Fax. +31 40 27 24825

Internet: <http://www.semiconductors.philips.com>

© Philips Electronics N.V. 1999

SCA63

All rights are reserved. Reproduction in whole or in part is prohibited without the prior written consent of the copyright owner.

The information presented in this document does not form part of any quotation or contract, is believed to be accurate and reliable and may be changed without notice. No liability will be accepted by the publisher for any consequence of its use. Publication thereof does not convey nor imply any license under patent- or other industrial or intellectual property rights.

Printed in The Netherlands

budgetnum/printrun/ed/pp15

Date of release: 1999 Apr 23

Document order number: 9397 750 05829

Let's make things better.

**Philips
Semiconductors**



PHILIPS